

**SURMOUNT™
PIN Diode**

**MA4SPS502
V1**

Features

- Surface Mount Device
- No Wirebonds Required
- Rugged Silicon-Glass Construction
- Silicon Nitride Passivation
- Polymer Scratch Protection
- Low Parasitic Capacitance and Inductance
- High Power Handling (Efficient Heatsinking)

Description and Applications

This device is a silicon-glass PIN diode chip fabricated with M/A-COM's patented HMIC™ process. This device features two silicon pedestals embedded in a low loss glass. The diode is formed on the top of one pedestal and connections to the backside of the device are facilitated by making the pedestal sidewalls conductive. Selective backside metalization is applied producing a surface mount device. The topside is fully encapsulated with silicon nitride and has an additional polymer layer for scratch protection. These protective coatings prevent damage to the junction and the anode air-bridge during handling and assembly.

These packageless devices are suitable for usage in moderate incident power (10 W C.W.) or higher incident peak power (500 W) series, shunt, or series-shunt switches. Small parasitic inductance, 0.35 nH, and excellent RC time constant, 0.22 pS, make the devices ideal for wireless TR switch and accessory switch circuits, where higher P_{1dB} and IP₃ values are required.

These diodes can also be used in π , T, tapered resistance, and switched-pad attenuator control circuits for 50 Ω or 75 Ω systems.

Dimensions

Dim	Inches		Millimeters	
	Min.	Max.	Min.	Max.
A	0.058	0.062	1.47	1.57
B	0.026	0.030	0.66	0.76
C	0.004	0.006	0.10	0.15
D	0.020	0.022	0.51	0.56
E	0.013	0.015	0.33	0.38

**Absolute Maximum Ratings¹
@ TA = +25 °C (unless otherwise specified)**

Parameter	Absolute Maximum
Reverse Voltage	1-275 V I
Forward Current	600 mA
Operating Temperature	-65 °C to +150 °C
Storage Temperature	-65 °C to +125 °C
Junction Temperature	+175 °C
Dissipated Power (RF & DC)	2 W
Mounting Temperature	+235 °C for 10 seconds

1. Operation of this device above any one of these parameters may cause permanent damage.

**Case Style ODS-1270^{1,2}
(Topview)**

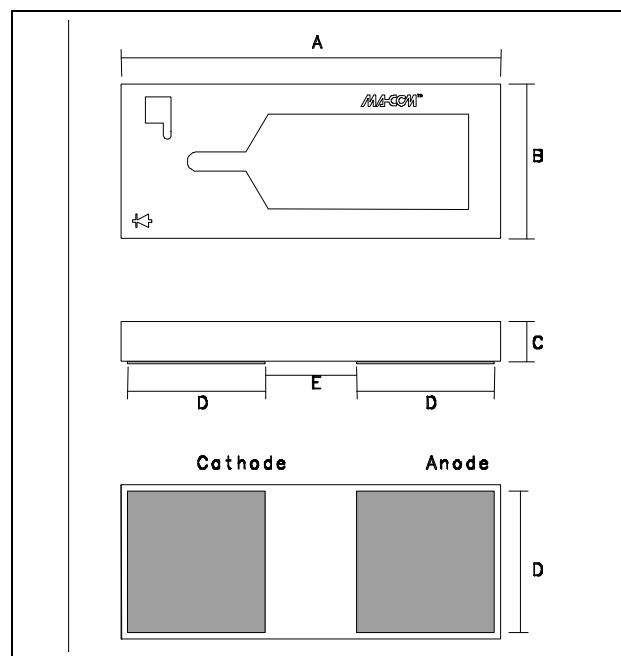

1. Backside metal: 0.1 micron thk. gold.
2. Shaded areas indicate bond pads.

**SURMOUNT™
PIN Diode**

**MA4SPS502
V1**

Electrical Specifications @ + 25 °C

Symbol	Test Conditions	Units	Min.	Typ.	Max.
C _T	-40 Volts, 1 MHz	pF		0.140	0.200
C _T	-40 Volts, 1 GHz	pF		0.090	
R _S	100 mA, 100 MHz	Ω		1.4	2.2
R _S	20 mA, 100 MHz	Ω		2.4	3.2
V _F	10 mA	V		0.87	1.00
V _R	10 μA	V	-200	-275	
I _R	-200 V	μA			-10
I _R	-40 V	nA		8	
R _{θJL}	Steady state	°C/W		50	
T _L	+10 mA / -6 mA measured at 90% voltage	μs		2.8	

Handling Procedures

All semiconductor chips should be handled with care to avoid damage or contamination from perspiration and skin oils. The use of plastic tipped tweezers or vacuum pickups is strongly recommended for individual components. Bulk handling should insure that abrasion and mechanical shock are minimized.

Bonding Techniques

Attachment to a circuit board is made simple through the use of surface mount technology. Mounting pads are conveniently located on the bottom surface of these diodes and are removed from the active junction locations. These devices are well suited for solder attachment onto hard and soft substrates. The use of 80/20 Au/Sn and 60/40 Sn/Pb solder is recommended, with an equal temperature profile across the contacts. Conductive epoxy paste for attachment may also be used.

When soldering these devices to a hard substrate, hot gas die bonding is preferred. We recommend utilizing a vacuum tip and a force of 60 to 100 grams applied normal to the top surface of the device. When soldering to soft substrates, it is recommended to use a lead-tin interface at the circuit board mounting pads. Position the die so that its mounting pads are aligned with the circuit board's mounting pads and reflow the solder by heating the

circuit trace near the mounting pad while applying 60 to 100 grams of force perpendicular to the top surface of the die.

Since the HMIC™ glass is transparent, the edges of the mounting pads closest to each other can be visually inspected through the die after attach is completed.

Functional Schematic¹

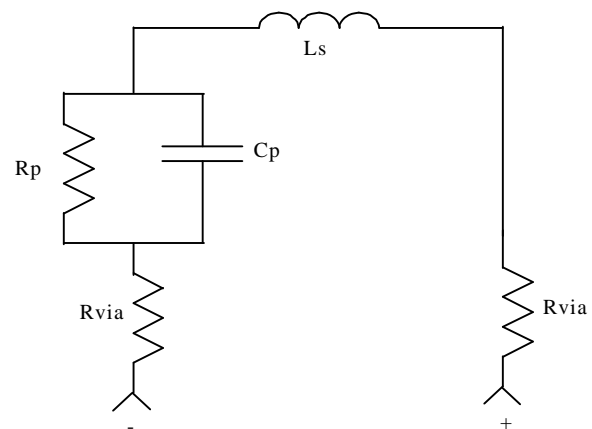

1. $R_s = 2 * R_{via} + R_p$

**SURMOUNT™
PIN Diode**

**MA4SPS502
V1**

Typical Performance Curves @ +25 °C

Typical Total Resistance R_S vs. Forward Current and Frequency

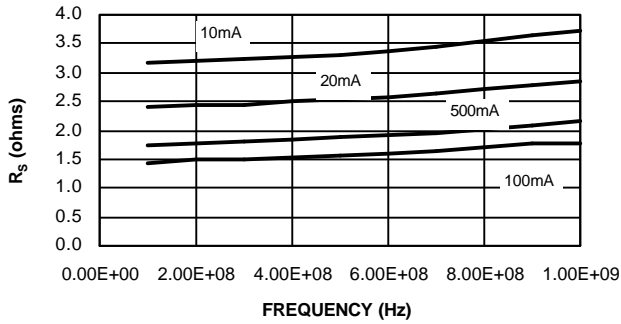

Typical Total Capacitance C_P vs. Reverse Voltage and Frequency

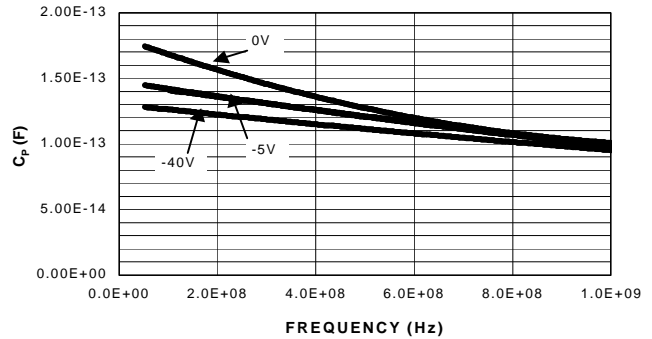

C_P vs. V_r @ 100 MHz and 1 GHz

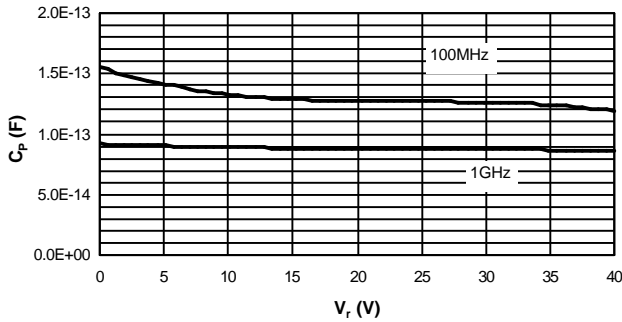

R_P vs. V_r @ 100 MHz and 1 GHz

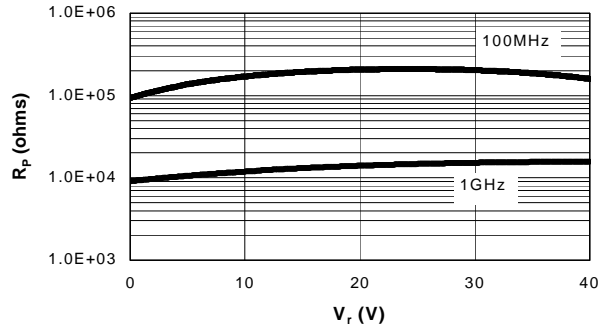

R_S vs. I_F @ 100 MHz and 1 GHz

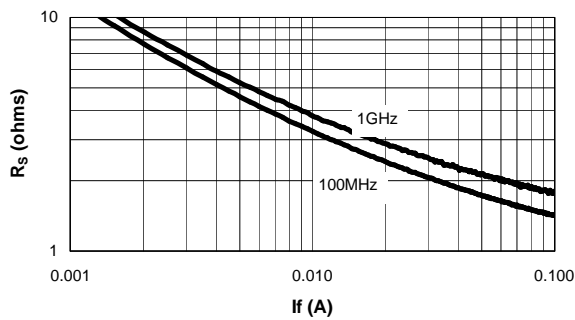

L_S vs. Frequency @ 10 mA

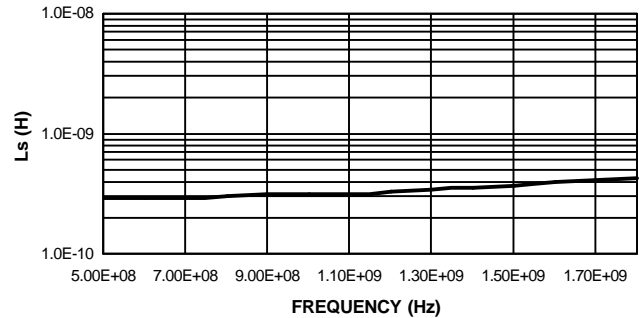

MA4SPS502 SPICE Model

PinDiodeModel wBv=200 V
 NLPINM1 wPmax=2.0 W
 Is=1.0E-14 A Ffe=1.0
 Vi=0.0 V
 Un=900 cm²/V-sec
 Wi=40 um
 Rr=20 K Ohm
 Cmin=0.12 pF
 Tau=2.8 usec
 Rs=0.1 Ohm
 Cj0=0.18 pF
 Vj=0.7 V
 M=0.5
 Fc=0.5
 Imax=2.5E+7 A/m²
 Kf=0.0
 Af=1.0

MA4SPS502 Schematic

